



EHS Combination and System Boilers Installation Manual



Heating for the Renewable Future

Please read through the whole instructions before removing the boiler from its packaging and installing and operating the appliance.

!! IMPORTANT NOTICE !!

**UNDER NO CIRCUMSTANCES MUST THIS BOILER
BE CONNECTED TO THE MAINS POWER WHILST
THE BOILER IS DRY.**

**THE BOILER MUST BE FILLED WITH WATER AND
PRESSURE TESTED PRIOR TO ELECTRICAL
CONNECTION.**

**FAILURE TO DO SO WILL INVALIDATE THE
WARRANTY**

INDEX

- 1. INTRODUCTION**
- 2. HEALTH AND SAFETY**
- 3. ESSENTIAL INSTALLER CHECKS TO BE MADE BEFORE UNPACKING AND INSTALLATION**
- 4. INSTALLATION REGULATIONS**
- 5. BOX CONTENTS AND UNPACKING**
- 6. ELECTRIC BOILER SCHEMATICS**
 - 6.1. Combination Boiler Schematic
- 7. INSTALLATION STEPS**
 - 7.1. Positioning and Wall Mounting the Boiler
 - 7.2. Design and connect the plumbing system
 - 7.2.1. Typical S plan Layout for system boiler.
 - 7.2.2. Typical layout for Combination Boiler
 - 7.3. System Piping Layout Design
 - 7.3.1. Design Considerations
 - 7.3.2. Heating And Hot Water Connections
 - 7.4. Flush and Fill Boiler.
 - 7.4.1. Flushing
 - 7.4.2. Heating System Fill.
 - 7.4.3. Hot Water System Fill
 - 7.5. Electrical Connections
 - 7.5.1. Electricity Connection Precautions
 - 7.5.2. Electrical Supply Connections
 - 7.5.3. Thermostat connections
 - 7.6. Powering On and Setting the parameters
 - 7.6.1. Power On
 - 7.6.2. Set The Boiler Parameters
 - 7.7. Set Pump Speed and Purge Air
 - 7.7.1. Initial Checks
 - 7.7.2. Turn On the Boiler
 - 7.7.3. Set The Thermostat
 - 7.7.4. Purge Air from The System
 - 7.7.5. Set Pump Speed
 - 7.7.6. Set Automatic Bypass Valve
 - 7.7.7. Check System Pressure and Top Up As Required
 - 7.8. Set Domestic Hot Water (DHW) Flow & Temperature
- 8. AFTER INSTALLATION OF MAIN BOILER**
 - 8.1. Heating Check
 - 8.2. Hot Water Check
- 9. OPERATION OF CONTROLS**
- 10. TROUBLESHOOTING GUIDE**
- 11. ELECTRICAL WIRING AND TECHNICAL DATA**
- 12. BOILER MAINTENANCE**
- 13. WARRANTY**

EHS Electric Combi and System Boilers

1. Introduction

The EHS Electric Boiler range will give years of trouble-free service and the following instructions will assist you in obtaining the best performance and most economical settings for your appliance.

ATTENTION: Only qualified engineers and approved service engineers are recommended for installing and servicing this product. Unqualified personal and the use of nonstandard parts can be dangerous and will invalidate the manufacturer's warranty.

The installation must be performed in accordance with current IEE Wiring Regulations, Building Regulations, Water Fitting Regulations (England and Wales) or Water Bylaws (Scotland) and all relevant British standards.

It is very important that you have read and fully understood this manual before installation of the EHS Electric Boilers to ensure their long life. This instruction manual should be kept in a place close to the appliance for easy reference. Please read the whole manual before attempting installation and follow these installation instructions and operating instruction to ensure long life of this EHS Boiler. These instructions must be conserved and given to any new user.

All EHS Electric Boilers are guaranteed from manufacturing defects for a full 5 years. To ensure that you are eligible for this guarantee you must register the boiler at www.ehs-heating.com within the time specified in the warranty terms and conditions. This can be found at the back of this manual and on the EHS website. The warranty relates to any manufacturing defects and covers the replacement of any faulty parts. The guarantee does not cover any damage or faults that are a consequence of poor installation or faults caused by leaks within the boiler. It is therefore very important that all connections are thoroughly checked by the installer prior to leaving it with the customer. All work that takes place under the guarantee must be agreed with EHS prior to commencing the installation.

This appliance must only be used and programmed by an authorised adult. It should not be used by children or anyone who has not read the installation manual. If in doubt, seek expert advice.

2. HEALTH AND SAFETY

At EHS we take every precaution where possible to design and manufacture our products to meet the safety requirements, when installed and operated according to the correct procedures. All products are comprehensively examined and tested before despatch.

Under the Consumer Protection Act 1974 it is a requirement to provide information on substances harmful or hazardous to health (COSHH Regulations 1988)

Materials used in the manufacture of this appliance are non-hazardous and do not require any special precautions when fitting or servicing this appliance.

It is the responsibility of the user or engineer to use the correct Personal Protective Equipment and Clothing when installing or working on this appliance.

3. ESSENTIAL INSTALLER CHECKS TO BE MADE PRIOR TO INSTALLATION

- 3.1. Carry out all heat loss calculations on the property and make sure that this boiler is suitable for the installation. EHS can assist with these calculations. Should you require this service please contact info@ehs-heating.com. HEAT LOSS CALC DONE?
- 3.2. For combination boilers you will need to carry out a hot water calculation to ensure that the boiler has a sufficient heat output to provide the correct temperature & flow of water required for the application. This will depend on flowrate required. If you need help calculating this, please contact info@ehs-heating.com. HOT WATER CALCULATION DONE?
- 3.3. Check the mains water pressure - The maximum pressure of the units is 6bar, where water pressure is close to or varies around this limit a pressure reducing set on the mains supply should be installed. MAINS WATER PRESSURE CHECK OK?
- 3.4. Check that the power supply to the premises meets the minimum requirements of the unit being installed. PREMISES POWER SUPPLY SUFFICIENT?
- 3.5. Carry out a voltage and load test to determine the correct sized cable and breaker is used. VOLTAGE AND LOAD TEST DONE? CABLE SIZE mm? BREAKER (AMPS)?
- 3.6. Check the central heating design is suitable for the application (Detailed recommendations are provided in BS EN 12828 and BS EN 6700.) SYSTEM DESIGN COMPATIBLE WITH PART L OF THE BUILDING REGULATIONS
- 3.7. If installing a combination boiler, check that the hot water flow rate from the boiler will be sufficient for the application. HOT WATER FLOWRATE OF COMBI BOILER SUFFICIENT?
- 3.8. When siting the boiler, consider the requirements for servicing the boiler (i.e. space around and in front of the boiler) and ensure that it is fitted in a location that cannot be accessed by unauthorised/unqualified people or children.
- 3.9. Make sure that this boiler is not installed in a shower compartment or bathroom.
- 3.10. The Boiler must be installed in an Upright position
- 3.11. Check that the boiler will be mounted on a suitable wall that can bare the weight of the boiler.
- 3.12. Ensure that all six fixing points are used when fixing the boiler to the wall.

Please make sure you have performed all the necessary checks above prior to opening the packaging, as we cannot take the product back for a free return if the packaging has been opened.

Finally, you can unpack the boiler from its packaging.

PLEASE NOTE EHS ARE NOT RESPONSIBLE FOR ANY FAILURES SHOULD THE ABOVE TERMS NOT BE MET

4. Installation Regulations

4.1. Installation of the boiler must comply with the following standards:

4.1.1. **The local building regulations**

4.1.2. **UK building regulations**

4.1.3. **BS EN 12828** - Heating systems in buildings: Design for water-based heating systems.

4.1.4. **BS EN 12831** - Heating systems in buildings: Method for calculation of the design heat load.

4.1.5. **BS EN 14336** - Heating systems in buildings: Installation and commissioning of water-based heating systems.

4.1.6. **BS7671** - Requirements for electrical installations. IEE Wiring Regulations. Seventeenth edition.

4.1.7. **BS EN 7593** - Code of practice for treatment of water in heating systems.

5. Unpacking and installation:

5.1. These appliances can weigh up to 28kg so please be aware that you will need 2 people to manually move and unpack the appliance.

5.2. Cut the seals as detailed below taking care not to penetrate inside the box otherwise this may scratch the appliance.

5.3. Fold the box lids back and remove the centre soft polystyrene packing

5.4. With one person at either end, lift the boiler gently out of the box.

5.5. Box Contents

5.5.1. Electric Boiler

5.5.2. 2 x (or 4 for Combi) Tectite Pipe connections

5.5.3. Wall mounting guide

5.5.4. 3 Expanding Wall bolts.

6. Electric Boiler Schematics

EHS System Boiler 1 Phase

NO.	Name	QTY	NO.	Name	QTY	NO.	Name	QTY
1	Signal line	1	11	Water pump	1	21	Electric control box components	1
2	Heater	1	12	Water flow switch G3/4	1	22	Wire	1
3	Single layer bracket	2	13	Water temperature probe D18	1	23	Cable Connector	1
4	Single valve	1	14	Water tank pipe	1	24	Body parts	1
5	Pressure switch	1	15	Pressure relief pipe	1	25	Expansion tank 5 litres - left side	1
6	Pressure gauge	1	16	Pressure relief valve 3 bar	1	26	Connecting wire	1
7	Pressure gauge mount	1	17	Thermostat 10A	1	27	Heating outlet pipe	1
8	Expansion board	1	18	Thermostat 60A single phase	1	28	Heating inlet pipe	1
9	Display B1006	1	19	Electronic control board	1	29	Cover	1
10	Display screen cover	1	20	Electric control box cover	1			

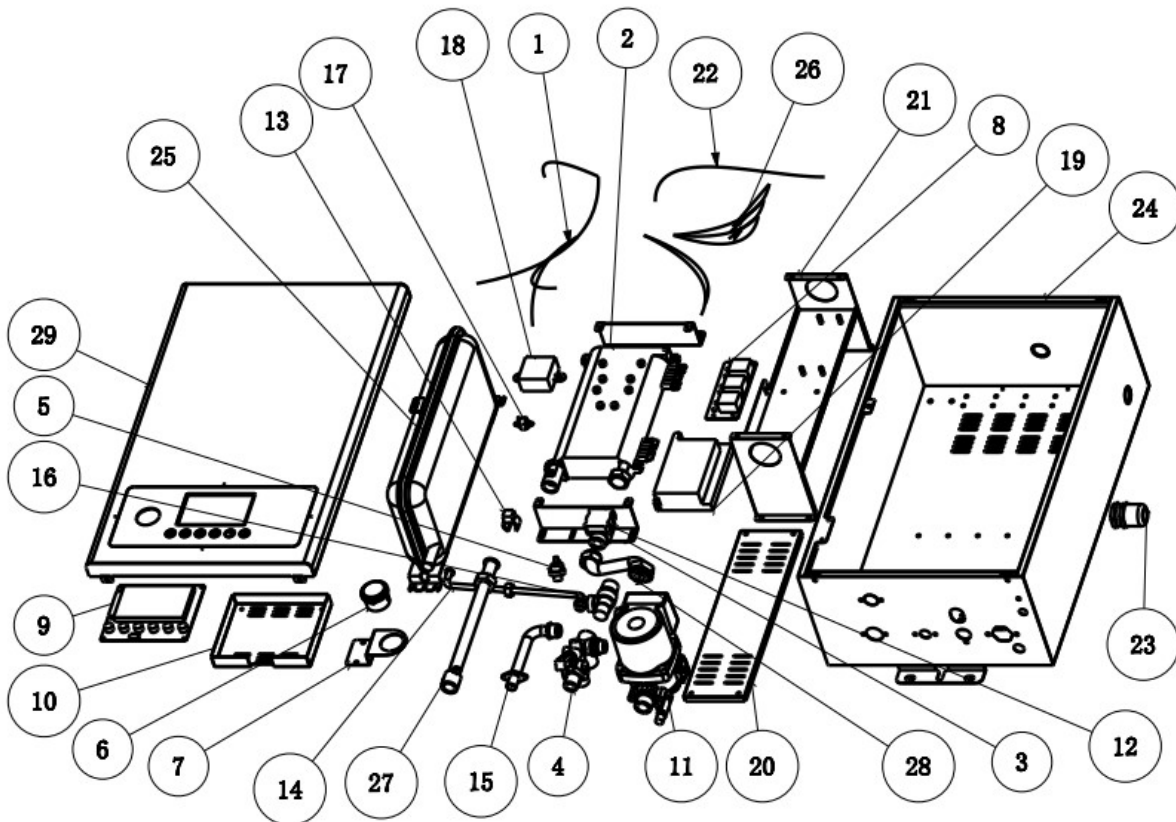

EHS Combination Boiler 1 Phase

NO.	Name	QTY	NO.	Name	QTY	NO.	Name	QTY
1	Signal line	1	13	Display screen cover	1	25	Thermostat 60A single phase	1
2	Heater	1	14	Water pump	1	26	Electronic control board	1
3	DHW heater	1	15	Water flow switch G3/4	1	27	Electric control box cover	1
4	SHW SCR	1	16	Water flow sensor	1	28	Electric control box components	1
5	DHW thermostat 60A	1	17	Water temperature probe D12	1	29	Wire	1
6	Pressure switch	1	18	Water temperature probe D18	1	30	Cable Connector	1
7	Pressure gauge	1	19	Water tank pipe	1	31	Body parts	1
8	Pressure gauge card board	1	20	Pressure relief pipe	1	32	Expansion tank 5 litres - left side	1
9	Double layer bracket	2	21	Pressure relief valve 3 bar	1	33	Connecting wire	1
10	Double valve	1	22	DHW outlet pipe	1	34	Heating outlet pipe	1
11	Expansion board	1	23	DHW inlet pipe	1	35	Heating inlet pipe	1
12	Display B1006	1	24	Thermostate 10A	1	36	Cover	1

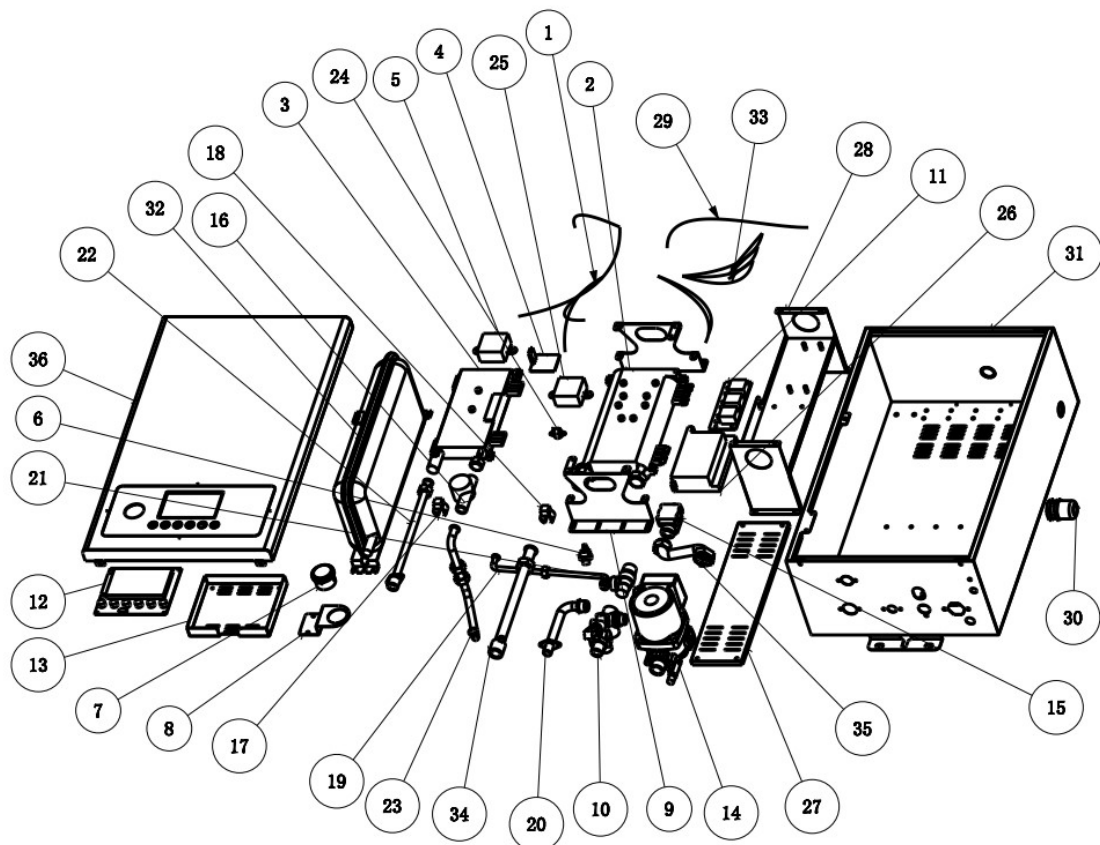

7. Installation steps

7.1. Positioning and Wall Mounting the Boiler

IMPORTANT:

When choosing a location to mount the boiler it is important that you consider clearance, servicing of the boiler, and safe and suitable operation.

When power is supplied, the boiler should only ever be opened by a qualified electrician after first isolating the electrical supply.

The boiler should be fitted out of the reach of children and people without the right skills and qualifications. If there is the possibility that the boiler could be opened without first isolating the electrical supply then you must install it in a fashion that prevents access to the boiler, such as a lockable cupboard.

The wall that you choose to mount this boiler on should be strong enough to support the boiler when full.

EHS recommend at least 100mm clearance from all fixed obstructions on all sides of the boiler. Allow plenty of space at the base of the boiler for fitting the hot and cold-water pipes and isolation valves.

Step 1. Drill 5 holes as per the included wall mounting diagram. The upper 3 holes should be $\Phi 8\text{mm}$ diameter, and the lower 2 holes $\Phi 6\text{mm}$.

Step 2. Secure the 3 $\Phi 8\text{mm}$ expansion bolts into the top three holes

Fig 1

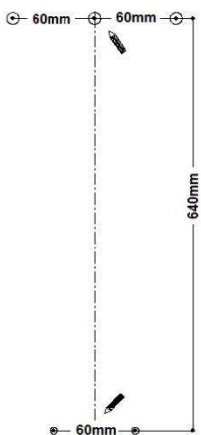
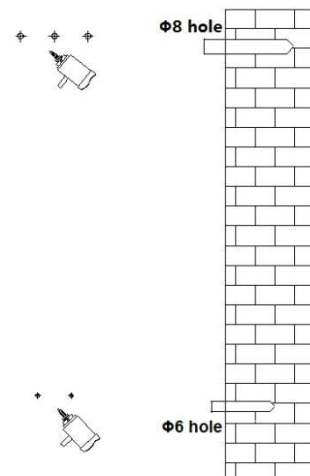
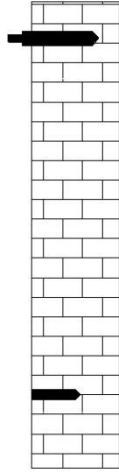

Fig 2



Step Three : Hang the boiler from the top three bolts before securing the boiler to the wall using standard fastenings at the bottom

Screw 3 x screws into 3 upper expansion screw bolts



Step Four: Hang the boiler on the 3 fixed screws. Then drill 2 screws into 2 under expansion screws

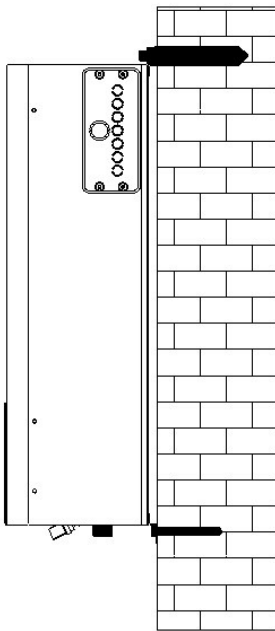

7.2. Design and connect the plumbing system

7.2.1. Typical S plan Layout for a system boiler

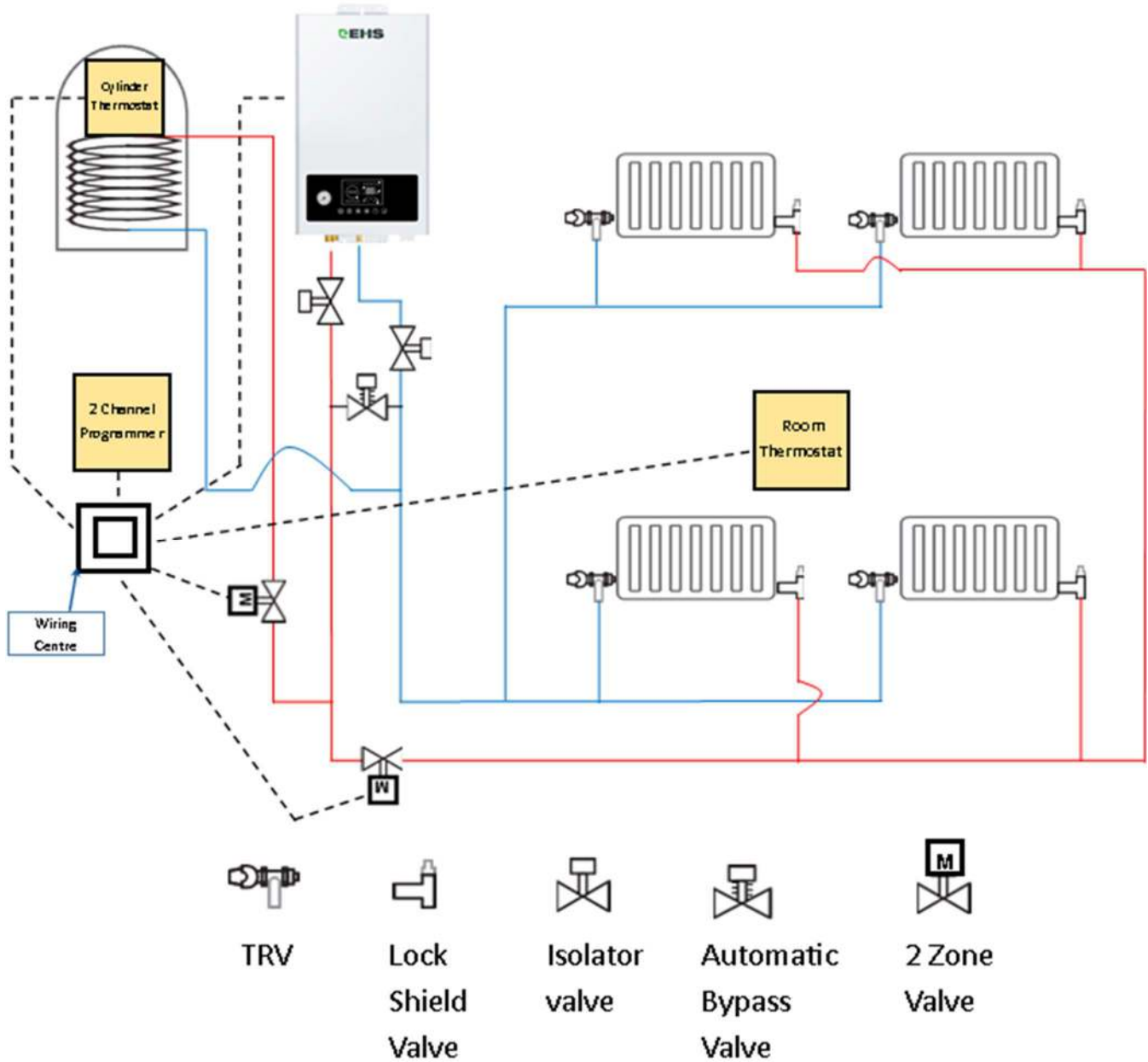

The layouts illustrated above are for guidance only. Please ensure that the boiler is fitted by a qualified plumber in line with current legislation.

7.2.2. Typical Layout for Combination Boiler

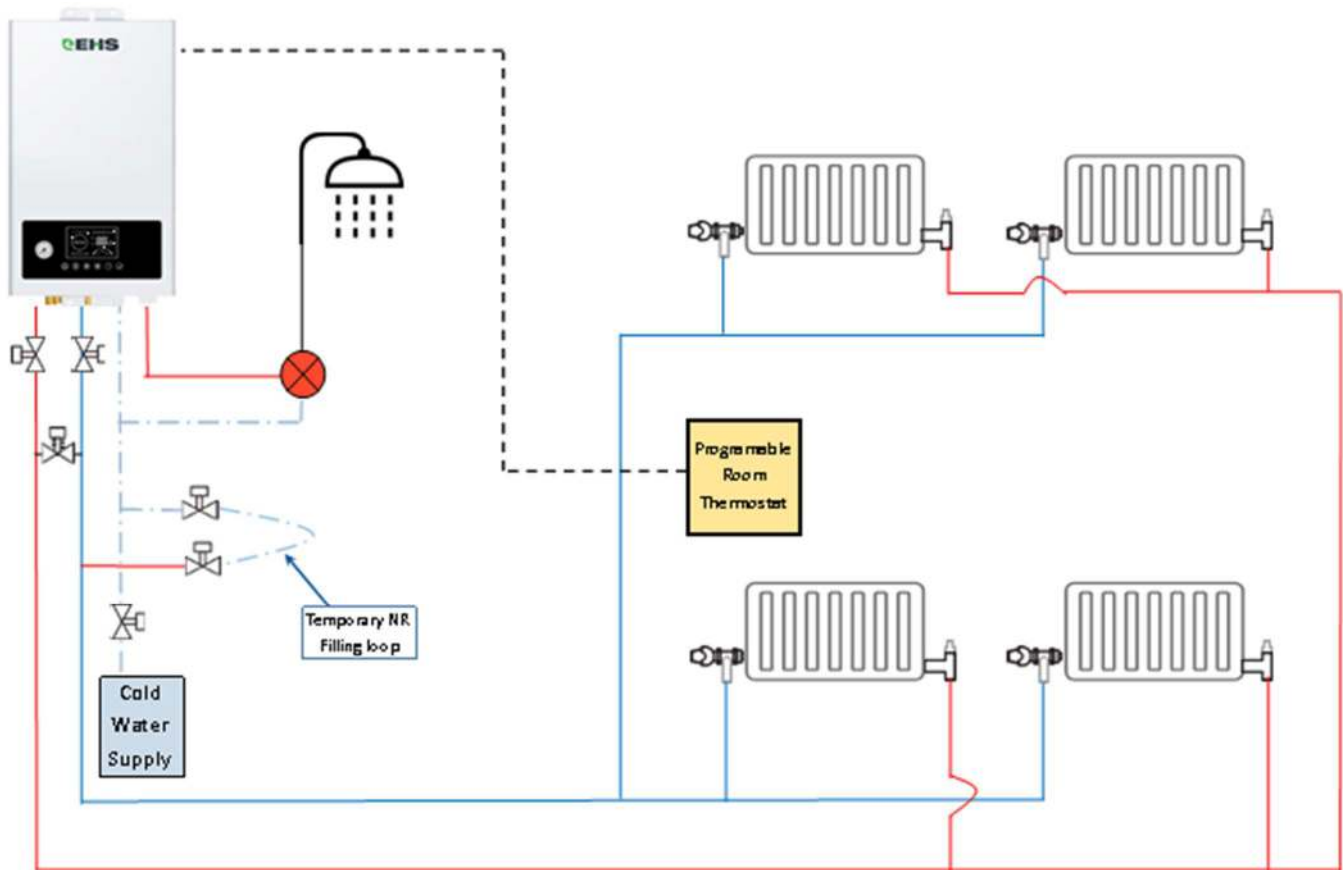

TRV



Lock
Shield
Valve



Isolator
valve



Automatic
Bypass
Valve

The layouts illustrated above are for guidance only. Please ensure that the boiler is fitted by a qualified plumber in line with current legislation.

7.3. System Piping Layout Design

7.3.1. Design Considerations

The boiler must be installed by a certified plumber or heating engineer and systems. Systems are to be designed to meet the current building regulations. EHS Limited are not responsible for faulty installations or installations that are made by unqualified people.

HEATING EXPANSION VESSEL A 5ltr expansion vessel is fitted internally within the boiler to provide room for thermal expansion of water under regular operating conditions. If the system contains significant volumes of water, an additional heating expansion vessel conforming to the current issue of BS4814 should be fitted externally. For any system an accurate calculation of vessel size is given in the current issue of BS5449 and BS7074 part 1.

AUTOMATIC BYPASS VALVE An automatic bypass valve **MUST** be installed as part of this installation. The ABV should be fitted to begin opening immediately the first radiator, valve or actuator shuts in the system. This stops excess pressure from building in the system on the flow side. **Failure to fit and set the ABV can result in poor performance and premature boiler failure**

ISOLATION VALVES: EHS recommend that **full bore isolation valves** are fitted on the flow and return pipework from the boiler. Standard ball valves will restrict flow and impede the flow in and out of the boiler which will result in poor performance.

AUTOMATIC AIRVENTS: The EHS Boilers have a built-in automatic air vent. If, however, the boiler is to be used alongside a hot water cylinder, you should fit an additional air vent in the vicinity of the cylinder coil.

SYSTEM FILLING: A WRAS approved filling loop must be used in such a way that it never becomes a permanent connection between the mains water and the heating system. There is a fill point on the boiler called a 'water replenishing valve'. A temporary connection can be made to this to fill the system or top up the pressure. Alternatively, this can be left closed, and a traditional filling loop installed. The heating system should be filled to 1.5bar when cold and topped up accordingly during commissioning. Please refer to BS EN 14336.

MAGNETIC FILTER: An inline magnetic filter should be fitted on the return side of the heating circuit to protect the boiler from debris from the heating system. This should be checked at every service interval or before if there is poor flow in the system. Failing to fit a magnetic filter will affect the warranty.

DRAIN POINT A drain point should be fitted at the lowest point of the heating system. It is not acceptable to drain the boiler through a safety valve as debris can prevent the correct operation of the valve

7.3.2. Heating And Hot Water Connections



- 7.3.2.1. **Cold & Hot Water Connections.** The cold water inlet and hot water outlet connections are 1/2" male thread connections. Use 2 x 1/2" female to 15mm pipe adapters with an isolation valve fitted to the cold supply connection. Make sure that the pressure of the mains water does not exceed 6 Bar. If the Mains Water pressure is more than 6 Bar a pressure reduction valve must be fitted. The minimum required pressure is 0,8 Bar. For hard water areas a water softener must be used. **Salt softeners must not be used to fill the heating system.** Note: Set the correct flow rate for the boiler output. If the flow rate is set too high, the Hot Water outlet temperature will not be achieved.
- 7.3.2.2. **Flow & Return Connections.** Flow & Return connections are G 3/4" male thread. Use 2 x 3/4" female to 22mm pipe adapters along with 2 x full bore isolation valves to provide good system circulation. The use of flexi hoses is preferred as overtightening of connections can twist and damage the internal pipework of the boiler (which is not covered under the warranty). An external magnetic filter must be used on all installations.
- 7.3.2.3. **PRV.** The boilers are fitted with a pressure relief valve. This has a barbed fitting for temporary applications. For permanent applications this can be removed, and we recommend fitting a 1/2" female connection to a 15mm copper pipe which should be discharged as per current building regulations. The PRV should never be used as a drain point as this could cause the device to leak.
- 7.3.2.4. **Automatic Bypass Valve** An automatic bypass valve **MUST** be installed as part of this installation. The ABV should be fitted to begin opening immediately the first radiator, valve or actuator shuts in the system. This stops excess pressure from building in the system on the flow side. Failure to fit and set the ABV can result in poor performance and premature boiler failure.
- 7.3.2.5. **Insulation.** We recommend that all pipework is insulated where practical. Especially the primary pipework within a boiler cupboard. This will reduce heat loss and protect the cupboard from high temperatures.

7.4. Flush and Fill Boiler.

7.4.1. Flushing:

The primary Heating circuit must be flushed according to BS7593. The system must be flushed with 10% of mains PPM or lower to ensure there is no debris trapped in the heating system, which would be detrimental to the lifespan of the boiler.

7.4.2. Heating System Fill.

A WRAS approved filling loop must be used in such a way that it never becomes a permanent connection between the mains water and the heating system. There is a fill point on the boiler called a 'water replenishing valve'. A temporary connection can be made to this to fill the system or top up the pressure. Alternatively, this can be left closed, and a traditional filling loop installed.

Proceed as below

- 7.4.2.1. Open the isolation valves that you have fitted to the flow and return of the heating system near the boiler.
- 7.4.2.2. Turn the cap on the 'automatic air vent' (behind the pump in the boiler) to ensure its not screwed down. It needs to be free moving.
- 7.4.2.3. Connect the filling loop to the 'water replenishing' connection
- 7.4.2.4. Open the replenishing valve and fill the system slowly checking for leaks on the connections as you do. Fill until the pressure on the pressure gauge reads between 1 and 1.5bar, then close the replenishing valve.
- 7.4.2.5. Vent the air out of the system and repeat the stage above
- 7.4.2.6. Check the system (including the inside of the boiler) for leaks. Please allow at least an hour of normal operation to confirm all fittings are leak free.**

7.4.3. Hot Water System Fill:

- 7.4.3.1. Open the isolating valve on the cold-water supply to the boiler
- 7.4.3.2. Open all hot water taps, showers, etc one by one until all the air has been purged from the hot water circuit.
- 7.4.3.3. Ensure that there is no air in the system by running the hot water taps until no spluttering can be seen or heard.
- 7.4.3.4. NOTE: If any air remains in the system when the boiler is turned on the water heater may fail prematurely.

7.5. Electrical Connections

All electricity connections to the boiler must be made by a fully qualified electrician. Improper electric connections made by unqualified people may cause failure of critical components of the boiler and will invalidate the warranty.



DANGER! Electric Shock Risk

Make sure to isolate the main power supply before starting work inside the boiler. Secure the main energy supply to prevent from turning on while working on the boiler.

!! IMPORTANT NOTICE!!

UNDER NO CIRCUMSTANCES MUST THIS BOILER BE CONNECTED TO THE MAINS POWER WHILST THE BOILER IS DRY. THE BOILER MUST BE FILLED WITH WATER AND PRESSURE TESTED PRIOR TO ELECTRICAL CONNECTION. FAILURE TO DO SO WILL INVALIDATE THE WARRANTY

7.5.1. Electricity Connection Precautions

- 7.5.1.1. We recommend that a load check is carried out when installing high power boilers.
- 7.5.1.2. All electrical connections must be made by a fully qualified electrician.
- 7.5.1.3. All wiring must be carried out in accordance with current IEE BS7671 wiring regulations. The supply cable to the boiler should be of sufficient size to carry the load capacity required. We recommend a high temperature multi strand flexible cable.

Rated Boiler Output	6kW	8kW	12kW	14kW
Single / Three Phase	Single	Single	Single	Single
Rated Voltage	230VAC	230VAC	230VAC	230VAC
Current (A) @ Rated Voltage	26	34	52	61
Minimum MCB/RCB (A)	32	40	63	63
Minimum Cable Size (mm²)	4	6	10	10

- 7.5.1.4. An upgrade to the main fuse of the property may be required.
- 7.5.1.5. As well as the boiler being properly earthed, this appliance requires supplementary earth bonding across all pipes connected to the boiler.
- 7.5.1.6. **Surge protection devices must be installed within the installation in-line with regulation 443 of BS7671. We recommend fitting an appropriately sized external RCD near to the boiler.**

7.5.2. Electrical Supply Connections

There is 650mm cable supplied with the boiler. The connections are already made within the boiler so there is no need to remove the cover to connect to the mains supply. We recommend fitting an appropriately sized RCD Next to the boiler so that it can be easily isolated if any work needs to be completed inside the boiler.

7.5.3. Thermostat Connections

The boiler cannot control external temperature or scheduling and therefore an external thermostat and programmer should be used to control the boiler to schedule the hot water or heating. These can be fitted as a single programmable thermostat or as an individual programmer and thermostat.

7.5.3.1 Thermostats must be fitted by a competent person, and installation must comply with the guidance provided in the current editions of BS767 (IEE wiring regulations) and part "P" of the building regulations.

7.5.3.2 There is no live supply from the boiler so the thermostat must be supplied by an external fused spur with either a 6amp or 3amp fuse depending on your thermostat

7.5.3.3 The Zero volt connection to the boiler is provided externally on the bottom right of the boiler.

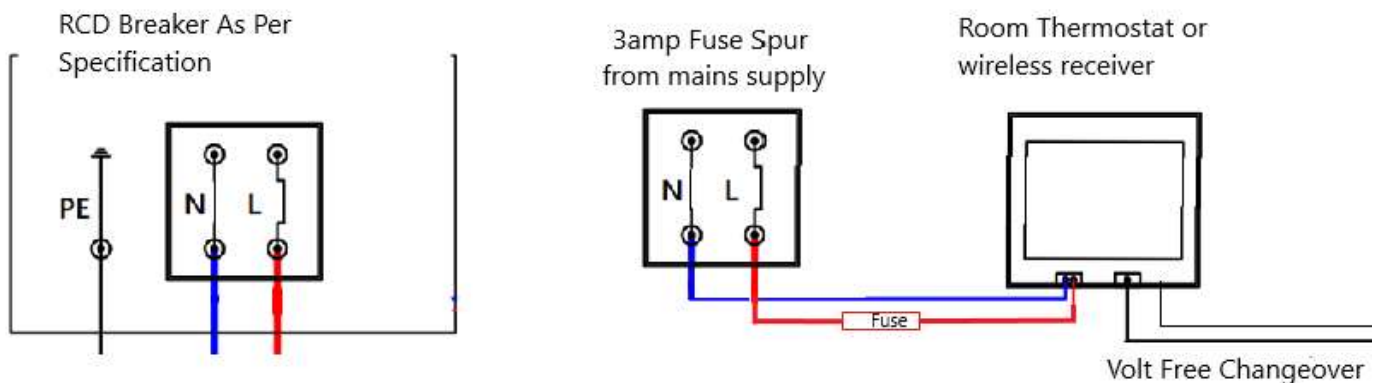

7.6. Powering On the Boiler and setting the Parameters

7.6.1. Power On









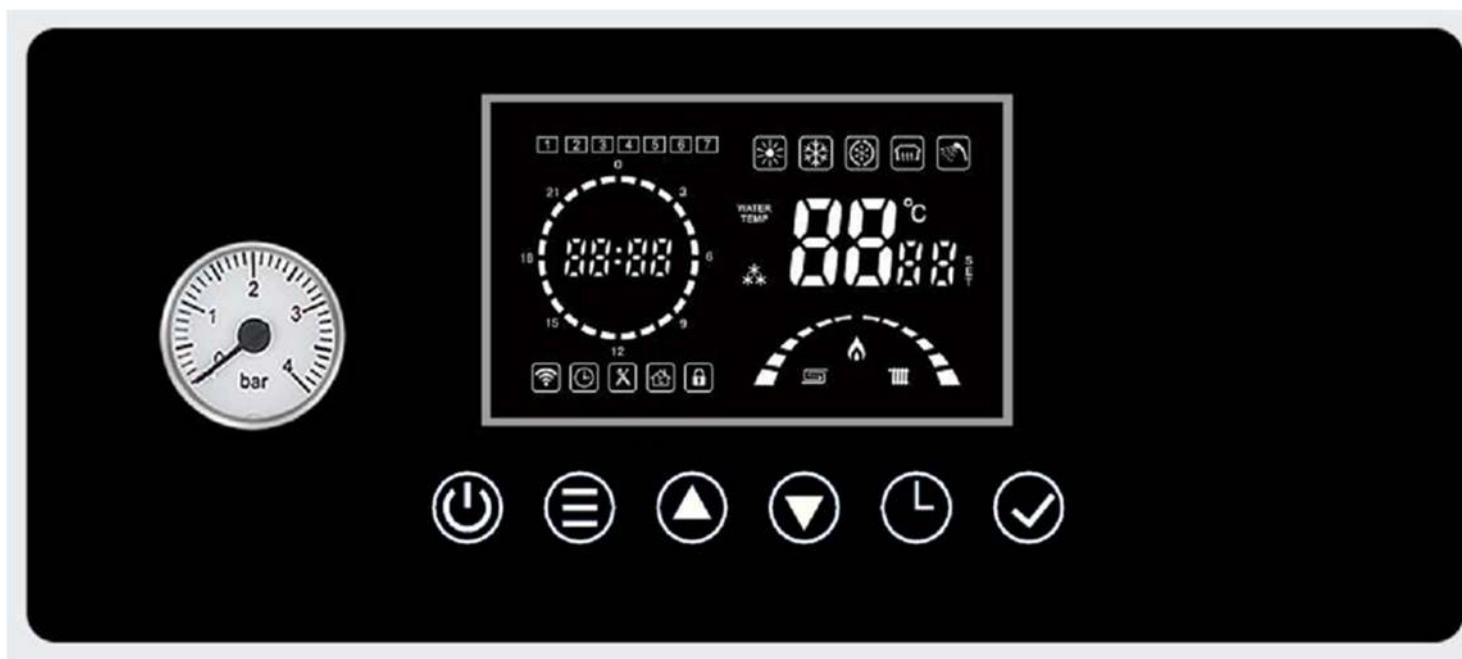

Before any power is turned on to the boiler it is important that it is checked for any loose connections. Check all connections including the factory-made ones as these can come loose in transit.











Prior to turning the boiler on for the first time, please make sure you have completed the following:

- 7.6.1.1. All STEPS in the manual so far, have been completed as instructed. The boiler must have been filled with water and isolating valves must be in the open position.**
- 7.6.1.2. The boiler casing is closed and secured.
- 7.6.1.3. Set the thermostat to the off position or lowest possible temperature.
- 7.6.1.4. By activating the appropriate RCD breaker in the consumer unit (or preferably next to the boiler) external to the boiler, this will put the Boiler into standby mode. Don't press the power on button yet but leave it in standby mode until the system parameters can be configured.

7.6.2. Key Operating Instructions and Functions.

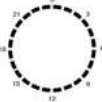





1		Turn On/Off. Toggle between winter and summer mode. Press to enter the function menu setting
2		Mode - go to each function menu
3		Up – Increase function parameter key
4		Down - decrease function parameter key
5		Enter the Daily 24hr Timing Menu Key
6		Confirm and exit / Fault clear key
	Actual temperature	Heating actual outlet temperature, bathroom actual outlet temperature.
	Water pump operation status	Lit--the pump is running. Off--the pump is not running.
	Hot Water/Shower	Lit—Hot water demand/function is running. Off—Hot water function is not currently required.
	Heating status	Lit - The equipment is in a heating condition.
	Winter mode	On--In winter mode. Have heating function and bath function in this mode.

	Summer mode	On--In the summer mode, hot water function is on, but heating is off.
	Time	Shows the current 24hr time in hours and the minute.
	Timing function status	On—Heating timing is controlled by the boiler. Off-- Heating timing is not controlled by the boiler
	Heating status	On--In heating. Off--No heating
	Heating setting temperature, Bathroom setting temperature, Fault code	In winter mode--Shows the heating setting temperature. In summer mode--Shows the Hot water setting temperature. Shows Fault Code when a fault occurs.
	Indoor temperature thermostat	On--Heating is required when the room temperature thermostat is closed Off--The room temperature thermostat is disconnected and heating is not required
	Anti-freezing function	On- Boiler in Anti-freeze mode – heating at 7degrees
	Timed period Icon	When the timing mode is turned on, and the blocks are lit, heating is required during the solid periods When the timing mode is turned on, and the blocks are blank, no heating is required in this period
	The heating indicator icon	On and flashing-In heating status Off and no flashing-Not in heating status
	Fault protection icon	On- Failure protection needs to view the fault code table Off- Failure-free
	Period display area	Light up at the specified day of the week. 1~7







There are 3 key parameters that need to be set to make the boiler function correctly: See section on how to set all the functions Press ON/OFF button to turn boiler into – Standby/Summer mode

7.6.2.1. **SET THE CLOCK** - In Standby Mode

- 7.6.2.1.1. Whilst in standby, Press  “MODE” key three times. Hour will start flashing
- 7.6.2.1.2. Press “UP / DOWN” to adjust the hour setting,



- 7.6.2.1.3. then press  "MODE" key again and minutes should flash.
- 7.6.2.1.4. Press at "UP / DOWN" adjustment.
- 7.6.2.1.5. Press  "CONFIRM" to store time the settings.
- 7.6.2.1.6. Day of Week Settings: In standby status, press  "MODE" 5 times and
  is flashing.
- 7.6.2.1.7. Press "UP / DOWN" to set the day of the week from 1~7.
- 7.6.2.1.8. Press  "CONFIRM" to complete the setting.

7.6.2.2. **HEATING FLOW TEMPERATURE:** The heating flow temperature is shown on the main panel. The default temperature is 65°C, however, this should be set to the design temperature of the heating system. The boiler can be set between 30°C - 80°C. In most cases 65°C will be correct, however underfloor heating systems and low temperature radiator systems maybe as low as 35°C. If using a hot water cylinder most systems would be remaining set at 65°C. This should be set correctly, or the boiler may experience overheating problems. To set this parameter press the Menu button again which will display 'Heat' on the front panel. Using the up and down arrow buttons set the desired temperature.

- 7.6.2.2.1. Press the  On/Off key to light up the  winter mode icon. This will also illuminate the actual setting temperature, the actual water outlet temperature, the thermostat/ indoor temperature control icon  , heating icon  , water pump icon  , Time  , heating icon, for the start-on heating state.

- 7.6.2.2.2. Set Temp: Press the "UP/DOWN" Key to adjust the temperature. Then, press the "CONFIRM" Key to take effect.

7.6.2.3. **SET FLOW DIFFERENTIAL:** The flow differential temperature is shown on the front panel of the boiler as "CH". This is the difference between the flow and return temperature. When 'CH' is set to 15°C and 'Heat' is set to 65°C the heat exchanger will switch off when the flow temperature reaches 65°C and allow flow to continue until the flow temperature reaches 50°C (15°C below 65°C), at which point the heat exchange will kick back in. The default setting for this parameter is 15°C.

- 7.6.2.3.1. Press and Hold  Mode until the Display show the "CH" return temperature menu.
- 7.6.2.3.2. Press "UP/DOWN" to adjust the return temperature setting.
- 7.6.2.3.3. Press  "CONFIRM" to set. (Note: Setting is from 5 ~30 °C, Factory default is 15°C)

For setting all other functions see 9.1

7.7. Set Pump Speed & Purge Air

The Boiler should still be in standby mode.

7.7.1. Please check the following before proceeding.

- 7.7.1.1. The boiler parameters have been set as above.
- 7.7.1.2. The air vent on the pump is open (dust cap is moving freely).
- 7.7.1.3. Set the pump to speed 1.

The boiler can now be activated

7.7.2. Turn On the Boiler –

Press and hold the power button until the boiler beeps and exits standby mode. The front panel should be showing a flashing thermostat symbol (if you have set your thermostat to off or its' lowest setting) and signals that the thermostat is not demanding any heating.

7.7.3. Set The Thermostat –

Turn the thermostat on and set to a temperature that would require heat. The thermostat symbol should be solidly lit. The pump will start and a few seconds later the ignition symbol will appear lit showing that the boiler has started to heat the water.

7.7.4. Purge Air from The System –

With the pump running start to purge all air from the system by bleeding all radiators and air vents. Once bled the system should run with very little noise coming from the boiler or pump.

7.7.5. Set Pump Speed –

Set this by adjusting the pump speed to achieve a 15 ~ 20°C differential between the flow and return temperatures.

7.7.6. Set Automatic Bypass Valve –

Set all TRV's to the open position (i.e. max temp). Now set the ABV to 'just closed'. To confirm this is correctly set, close one of the TRV's and that should allow a small amount of flow past the ABV.

7.7.7. Check System Pressure and Top Up As Required –

Don't forget to disconnect the filling loop and ensure that all connections are capped to avoid leaks.

7.8. Set Domestic Hot Water (DHW) Flow & Temperature

In order to get hot water from the combination boiler at the required temperature you must set the flow rate of the cold water coming into the boiler. This can be achieved by restricting the isolation valve on the cold inlet to

the hot water side of the boiler. Please see below the recommended flow rates of cold water below for the differing sized boilers. These flow rates are based on a 30°C rise in temperature of incoming to outgoing water

Rated Combi Boiler Output	12kw	14kw
Recommended Flowrate (ltr/min)	6	7

To Set the Hot water Temperature

- 7.8.1. Open a Hot tap and let it run.
- 7.8.2. Adjust the hot water temperature on the boiler by using the up and down arrows the boiler.
- 7.8.3. With the hot water tap open and running the temperature of the hot water outlet can now be set on the boiler by using the up and down button. The temperature cannot be adjusted without a hot tap being open. Remember this setting does not guarantee the output, it only sets the maximum possible output, the output temperature will rely on the flow rate going into the boiler as above.

8. Install complete??

Finally check Heating and Hot water is working correctly.

8.1. HEATING CHECK

- 8.1.1. Turn the thermostat to a temperature to 5 degrees above current room temperature and check that the boiler heating fires. This is confirmed by the Ignition symbol and the Temperature symbol being solidly lit.
- 8.1.2. Let the boiler run for a few minutes and then check that the radiators are starting to heat up.
- 8.1.3. After 15 minutes check the temperature difference between the flow and return is between 15 to 20oC. If not adjust pump speed accordingly
- 8.1.4. Wait until the thermostat reaches temperature and deactivates the boiler.
- 8.1.5. Again set the thermostat another 5 degrees higher and wait for a few minutes to check that the boiler successfully fires again.
- 8.1.6. If it does, the testing is complete. Set the thermostat to normal operating temperature.

8.2. HOT WATER CHECK

- 8.2.1. Open a hot water tap and ensure that the boiler fires.
- 8.2.2. Give the boiler a few minutes to reach temperature.
- 8.2.3. Check that the tap is outputting water at the correct temperature. If not please refer to section 8
- 8.2.4. Close the hot water taps to complete testing

PLUMBERS CHECKLIST

COMPANY NAME.....

PLUMBERS NAME.....

COMPANY ADDRESS:.....

COMPANY TELEPHONE:.....

DATE OF INSTALLATION.....PRODUCT CODE.....

WAS THIS A EXISTING INSTALL OR NEW INSTALL? EXISTING NEW INSTALL

HOW MANY HEATING ZONES ARE INSTALLED? 1 2 3+

HAS THE FILLING LOOP BEEN REMOVED & CAPPED OFF? YES NO

WAS AN ABV FITTED? AT WHAT SETTING? YES NO SETTING

WHAT IS THE HEATING PRESSURE SET AT? Bar

WHAT IS THE INCOMMING MAINS PRESSURE? Bar

WHAT HAS THE BOILER FLOW TEMPERATURE BEEN SET AT? o C

WHAT HAS THE BOILER DIFFERENTIAL TEMP. BEEN SET AT? o C

WHAT PUMP SPEED HAS BEEN SET ON THE BOILER?

Notes;-

[Empty rectangular box for notes]

BY SIGNING YOU AGREE THAT YOU HAVE INSTALLED THE BOILER IN ACCORDANCE WITH THIS MANUAL AND THAT THE BOILER IS WORKING AS INTENDED WITHOUT ANY LEAKS AND ALL INSTALLER MADE AND FACTORY-MADE CONNECTIONS HAVE BEEN CHECKED

SIGNED:

DATE:

ELECTRICIANS CHECKLIST

COMPANY NAME

ELECTRICIANS NAME

COMPANY ADDRESS:

COMPANY TELEPHONE:

DATE OF INSTALLATION:

WHAT IS THE INCOMING MAINS VOLTAGE AT THE FUSE BOARD? VAC

WHAT IS THE INCOMING MAINS VOLTAGE AT THE APPLIANCE? VAC

WHAT SIZE BREAKER HAS BEEN FITTED FOR THE BOILER? AMPS

WHAT IS THE DRAW OF THE APPLIANCE FOR HEATING? AMPS

WHAT IS THE DRAW OF THE APPLIANCE FOR HOT WATER? AMPS

WHAT SIZE CABLE WAS INSTALLED TO THE APPLIANCE? . MM2

WHAT IS THE APPROXIMATE CABLE RUN TO THE BOILER? M

WHAT TYPE OF CABLE HAS BEEN USED?

Notes:-

BY SIGNING YOU AGREE THAT YOU HAVE INSTALLED THE BOILER IN ACCORDANCE WITH THIS MANUAL AND THAT THE BOILER IS WORKING AS INTENDED WITHOUT ANY LEAKS AND ALL INSTALLER MADE AND FACTORY-MADE CONNECTIONS HAVE BEEN CHECKED

SIGNED:

DATE

9. Trouble Shooting

Error Code	Protection Function	Potential Cause	Potential Solution
------------	---------------------	-----------------	--------------------





E0	Self-checking fault of leakage circuit	Circuit board is damped, or temperature change causes water mist.	1. Check whether a signal line on the electric leakage protection coil has fallen off or not. 2. Replace PCB.
E2	Electric leakage on system	Check whether the external power supply has leakage or whether there is condensation or water leakage on the main circuit board.	1. Switch off the boiler 2. Qualified engineer to open cover and dry/inspect circuit board.
E3	Heating Water Temperature Sensor broken/loose	Sensor is in short circuit or open circuit.	1. Check if the sensor connection is loose or not. 2. If broken contact EHS customer service to replace sensor.
E5	Domestic hot water temperature sensor broken	Sensor is in short circuit or open circuit.	1. Check if the sensor connection is loose or not. 2. If broken contact EHS customer service to replace sensor
E9	Antifreeze fault	Heating water temperature is too low	1. If the heating pipework is frozen, the boiler will not be able to work. 2. Clean pipeline, refill the water then switch on.
EC	Display Disconnected from PCB	Display Disconnected from PCB	1. Check whether the connection between the cable and the PCB is broken or loosen. 2. If broken Contact EHS customer service to replace cable/PCB.
F1	Dry Fire Protection	No Water Flow	1. Check whether the water flow circuit is ok or not. Check Isolating valves are open. 2. Fill system and vent Press and hold TIME key for 6 seconds to re-set
F4	Water Pressure Fault	System is low on water	1. Fill to correct pressure with filling loop 2. Check whether the water pressure of the system drops and check for leaks. 3. Check whether the pressure switch is blocked, or it has fault.
F6	No water flow circulation	Air in the system, no water or water pump not working, pump is blocked, water flow switch blocked, water flow switch is faulty.	1. Vent system. 2. Check system pressure. 3. Check pump and flow switch for blockage/operation







Error Code	Protection Function	Potential Cause	Potential Solution
------------	---------------------	-----------------	--------------------

E6	Neutral wires not well connected	No heating	<ol style="list-style-type: none"> 1. Check whether the neutral wire of the machine has false connection. 2. Check whether the neutral wire end of the leakage protection switch is damaged. 3. Measure whether the voltage between the neutral wire and the live wire is 220 v. 4. Contact the customer after sales to replace the motherboard.
	External leakage protector tripped	Display screen does NOT light up.	<ol style="list-style-type: none"> 1. Check whether the leakage protector is damaged and replace it. 2. Check whether the heater has leakage and change it. 3. Check whether there is leakage situation in the external input power wires and repair the line.
	Dry burning temperature controller trip	Display screen does NOT light up.	<ol style="list-style-type: none"> 1. Check whether the temperature controller trips. If it trips, press the reset button. 2. Check whether the waterway is blocked. Clean and unblock the pipeline. 3. Check the flow of water pump.
	No heating	Equipment temperature does NOT rise.	<ol style="list-style-type: none"> 1. Water temperature setting too low. 2. Return temperature setting too high. 3. Timing and opening 4. Indoor temperature control setting too low.





10. All functions

10.1. **Summer/Standby mode (hot water only)** : Press the  On/Off Key to illuminate the Summer Mode

icon  . It will also illuminate the Actual set temperature, Actual water supply temperature, thermostat/Indoor temperature control icon , Day icon  and Time  .

10.2. **Winter mode:** Press the  On/Off key to light up the  winter mode icon. The following will also illuminate - the actual setting temperature, the actual water outlet temperature, thermostat/indoor temperature control icon , heating icon , water pump icon , time , day  .

10.3. **HEATING FLOW TEMPERATURE:** The heating flow temperature is shown on the main panel. The default temperature is 65°C, however, this should be set to the design temperature of the heating system. The boiler can be set between 30°C - 80°C. In most cases 65°C will be correct, however underfloor heating systems and low temperature radiator systems maybe as low as 35°C. If using a hot water cylinder most systems would be remaining set at 65°C. This should be set correctly, or the boiler may experience overheating problems. To set this parameter press the Menu button again which will display 'Heat' on the front panel. Using the up and down arrow buttons set the desired temperature.

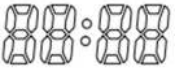
10.3.1. Press the  On/Off key to light up the  winter mode icon. This will also illuminate the actual setting temperature, the actual water outlet temperature, the thermostat/ indoor temperature control icon , heating icon , water pump icon , Time , heating icon, for the start-on heating state.

10.3.2. Set Temp: Press the "UP/DOWN" Key to adjust the temperature. Then, press the "CONFIRM" Key to take effect.

10.4. **FLOW DIFFERENTIAL:** The flow differential temperature is shown on the front panel of the boiler as "CH". This is the difference between the flow and return temperature. When 'CH' is set to 15°C and 'Heat' is set to 65°C the heat exchanger will switch off when the flow temperature reaches 65°C and allow flow to continue until the flow temperature reaches 50°C (15°C below 65°C), at which point the heat exchange will kick back in. The default setting for this parameter is 15°C.

10.4.1. Press and Hold  Mode until the Display show the "CH" return temperature menu.

10.4.2. Press "UP/DOWN" to adjust the return temperature setting.

10.4.3. Press  "CONFIRM" to set. (Note: Setting is from 5 ~30 °C, Factory default is 15°C)

10.5. **Radiator  mode/ Floor heating  mode setting:**

10.5.1. Press the  "MODE" key twice in the standby state to enter the radiator / floor heating mode selection,

10.5.2. press the "UP / DOWN" to select

10.5.3. Press the  "CONFIRM" to set.

10.6. **Time Setting:**

10.6.1. In standby/Summer mode Press  "MODE" key 3 times to get hours flashing

10.6.2. Press “UP / DOWN” to adjust hour,

10.6.3. then press  “MODE” key again to get minutes to flash

10.6.4. Press “UP / DOWN” adjustment for minutes.

10.6.5. Press  “CONFIRM” to complete the setting.

10.7. Week Settings:



10.7.1. In Standby/Summer mode status, press  “MODE” 5 times and  is flashing.



10.7.2. Press “UP / DOWN” to set the day of the week.

10.7.3. Press  “CONFIRM” to complete the setting.

10.8. Boiler 24 Period timing and each timing temperature set:

10.8.1. Press  “Clock” key to enter the on / off time setting, the 24-hour time period flashes.

10.8.2. Press “UP / DOWN” to make the on / off hour setting. (Note: Press “UP” Select this segment time on-the segment lamp is on , Press “DOWN” Cancel the segment timing-segment light off . And

then press “MODE” and the  flashes. Press “UP / DOWN” to set the temperature. Long press  “Clock” for 3 seconds until the  icon is light and timing function starts.

10.8.3. (1-24) Time on / off / temperature setting is completed. After the appointment time / temperature setting, press the “TIME” for 3 seconds to enter the reservation time / temperature on / off. If there is no need to set the timing function, press the 3-second “TIME” key to exit the reservation function.

Note: (The second grid from left to right is the first hour.)

10.9. Heating temperature setting:

10.9.1. In radiator mode , the heating water temperature can be set 30°C-80°C.

10.9.2. In floor heating mode , the heating water temperature can be set 30°C-60°C

10.10. Direct Hot Water temperature setting range: Hot water temperature can be set up the temperature range: 30°C -60°C.

11. Electrical Circuit Diagrams and Technical Data

Circuit Diagram

EHS System Boiler 1 Phase

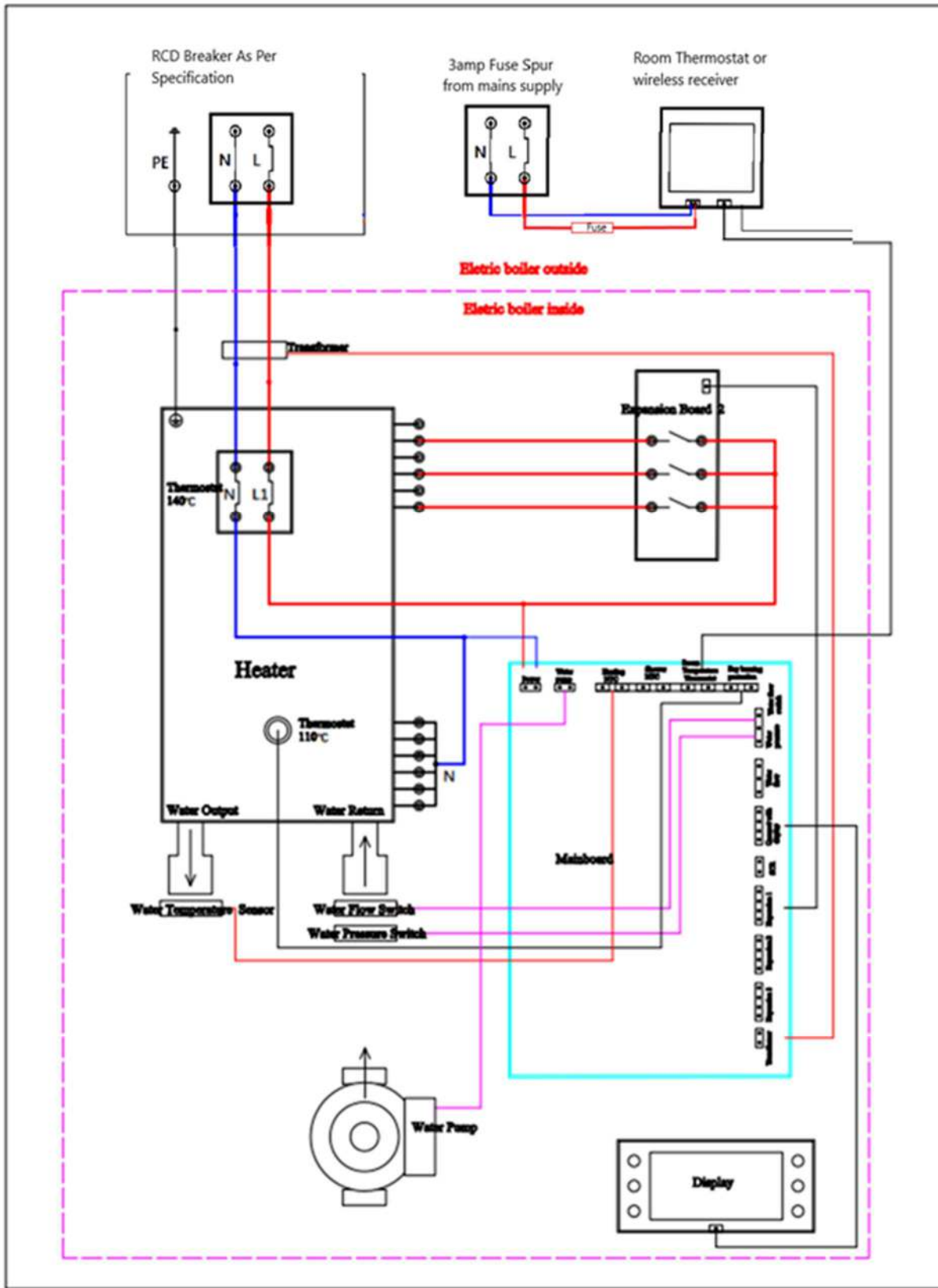

EHS Combination Boiler 1 Phase Circuit Diagram

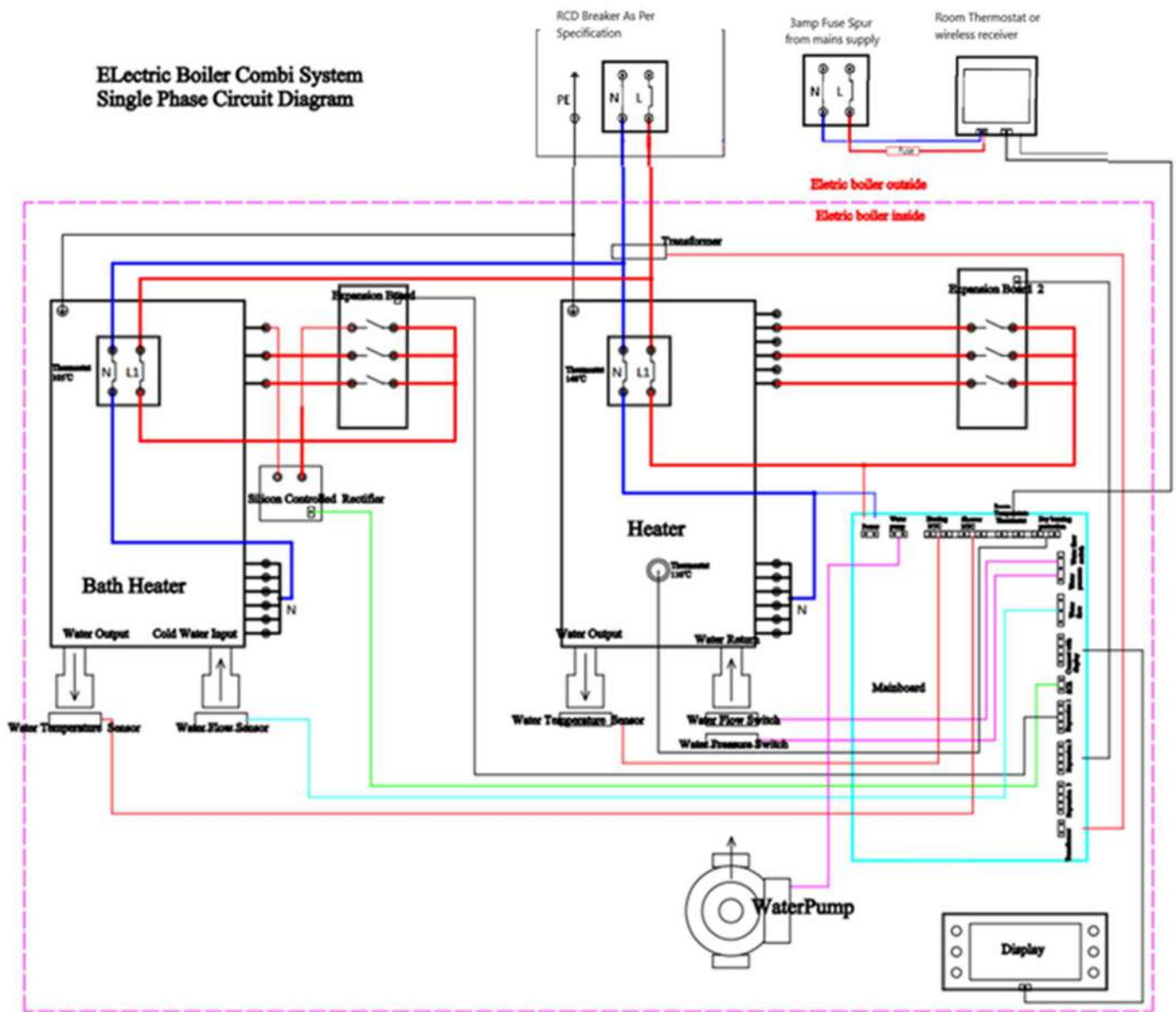

Technical Data

Model System Boiler	ALC1-1PSY-6	ALC1-1PSY-8		
Model Combi Boiler			ALC1-1PCO-12	ALC1-1PCO-14
Voltage	230V			
Frequency	50Hz/60Hz			
Phase	1			
Power KW	6	8	12	14
Current A	31.8	36.4	54.5	61
Wire mm²	4	6	10	16
Circuit Breaker A	32	40	63	63
Working Temp. Range	30°C~80°C (in radiator mode)			
	30°C~55°C (in Underfloor heating mode)			
Max. Water Temperature	85°C			
Temperature Difference	5~20°C			
Setting Range	Adjustable between 30 and 85°C			
Antifreeze Start Temperature	<8°C			
Anti-freezing function stop temp.	≥10°C			
Output Voltage of Pump	230V ac, 0.4A			
Capacity of Expansion Tank	5L			
Inlet & Outlet Connection	G1/2"			
Flow and Return connection	G3/4"			
Product Size EHS System Boiler	630mm*380mm*230mm			
Product Size EHS Combi Boiler	630mm*380mm*230mm			

12. BOILER MAINTENANCE

EHS electric boilers do not require maintenance other than the following:

The heating system must be filled and maintained when the water is cold, between a pressure of 1 – 3 bar. Frequent refilling of the system can cause scaling, corrosion and damage to a heating system and should be avoided wherever possible. Regular pressure loss could be indicative of a leak within the system and should be investigated.

UNDER NO CIRCUMSTANCES SHOULD THE BOILER BE SWITCHED ON WHEN THE SYSTEM IS DRY.

The boiler contains an installed frost-protection program. For this to operate, power must be always supplied to the boiler.

Anti-freeze can be added to the heating system (no more than 20% by volume) if the boiler is going to be stood unused for long periods of time. Otherwise, the boiler should be disconnected from the electricity supply and the system fully drained to avoid any frost damage.

13. WARRANTY INFORMATION

All EHS products are supplied in accordance with standard Terms & Conditions (available on request or via our website). This Policy also applies in addition to our terms and conditions to any EHS electric Boilers and by fitting this product you are agreeing to be bound by these Terms & Conditions and this Policy. This Policy sets out the Warranty Period and exclusions which apply to Electric Boilers, for other products please see our website or their corresponding manuals. This Policy is subject to our Standard Terms and Conditions and should be read in conjunction with those terms. We reserve the right to amend this policy at any time.

Warranty Details:

Warranty and Liabilities

19. The installer must be suitably qualified to install products and all Commissioning Sheets & Annual Servicing Sheets require to be made available to us when requested.
20. The product must be installed as per the installation instructions.
21. The Warranty must be registered with EHS by either the Installer or the Householder, within 30 days of the Boiler being installed. Failure to do so will reset the Warranty Period to 1 Years for Parts and Labour only.
22. For products registered within the stated time frame, the 5 Year Warranty will comprise of 2 Years Parts and Labour with a further 3 years Parts only.
23. To comply with our Warranty Terms the product must be serviced each year as outlined in the product installation manual. The service must be carried out by a suitably qualified engineer and a record of that service kept by the owner. The service can be within a 30 day period of the anniversary of the last service, without invalidating the Warranty.
24. If the service is not carried out in accordance with the guidelines within the product installation manual, the Warranty cover will become void.
25. During the Warranty period, we will replace parts which were faulty from the date of purchase, at our discretion free of charge. Reasonable Labour costs will only be paid where the value has been pre-agreed and authorised by EHS prior to the repair.
26. This Warranty is limited to the purchased product only and does not include any connected products or systems.
27. If the product breaks down or is showing a fault and requires an engineer to visit, we may ask you to pay a deposit prior to the repair visit. We will return the deposit in full if we find a fault that is covered by the Warranty. We may keep the deposit if we cannot access your property at the agreed visit time or conditions mentioned in point 23 above of this Warranty have not been met. A responsible adult must be at the property to provide access to the Engineer.
28. Any repair carried out under the terms of this Warranty does not extend the Warranty beyond its original period.
29. The Warranty only applies to products bought and used in the United Kingdom.
30. For products installed in the Channel Islands and Isle of Man the only a 2 Year Parts & Labour Warranty is applicable.
31. Engineers will not carry out repairs if they think accessing the product would be a risk to Health and Safety. We will not be liable for any costs if there is a health and safety issue
32. There must be sufficient room for the Engineer to work (the minimum area is set out in the installation instructions). We will not accept responsibility for removing cupboards, kitchen units, trims etc to gain access for repairs.
33. This Warranty does not in any way affect your Statutory or Legal Rights.

34. A central heating inhibitor (Fernox or equivalent) is required to be added to the system during installation and thereafter at regular intervals using the correct dosage.

35. A magnetic filter requires to be installed on the return of every Boiler. This must be cleaned at every yearly service.

36. Existing systems require to be pressure flushed correctly and final TDS reading recorded on the commissioning paperwork.

37. This Warranty does not cover the following:

- Parts which fail due to system debris, contamination and/or water quality issues,
- Boilers installed within mobile leisure accommodation. e.g., Boats, Mobile Caravans.
- Any extra costs incurred whilst undertaking a repair due to incorrect installation
- Products that have been moved from their original place of installation.
- Costs of each annual service, including consumable parts such as seals and chemical treatments (inhibitor etc.)
- Any repair that is needed because of anything other than a fault to the Boiler or failure of the Boiler itself.
- Any 3rd party damage, whether accidental, negligent, malicious, or otherwise.
- Theft or attempted theft.
- Any fault or failure in the heating system to which the Boiler is connected.
- Any other costs or expenses caused by or arising because of a repair.
- Any damage caused by hard water scale deposits or sludge resulting from corrosion.
- Any problems caused by inadequate supply of services such as electricity or water to the property including loss of power.
- Boilers where:
- EHS Genuine Parts have not been used in any service or repair or
- They have not been Installed and set up strictly in line with the installation instructions supplied with them (including the requirement to clean the system and add corrosion inhibitor in line with BS7593:1992); or
- They have not been maintained strictly in line with the maintenance instructions supplied with them.

EHS Customer Service

Contact us on

Email – Info@ehs-heating.com

Phone- +44 (0)345 8628699